



rodents

birds

Scaletta inclusa
Ladder included



fish and turtles



 **01063**



optional pag. 101









optional pag. 102

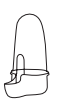

→ 50 ← 30 ↑ 65 cm

12,10 mm 

 → 51 ← 31,5 ↑ 57 cm - Vol. 0,092 m³

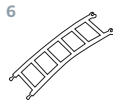
- | | | | | | |
|--|--|---|---|---|---|
| <p>1 </p> <p>● 90799B  X15</p> <p>● 90799  50</p> | <p>2 </p> <p>● 60190B  X10</p> <p>● 60190  15</p> | <p>3 </p> <p>● 96696B  X10</p> <p>● 96696  100</p> | <p>4 </p> <p>● 31995  1</p> | <p>5 </p> <p>○ 75210  1</p> | <p>6 </p> <p>● 95896B  X6</p> |
|--|--|---|---|---|---|

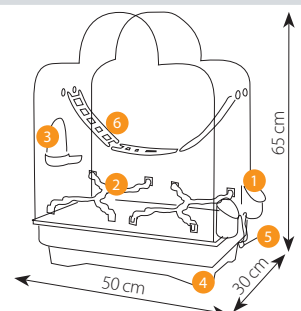

cats & dogs